

Operating instructions Delta fanning blower DA TR

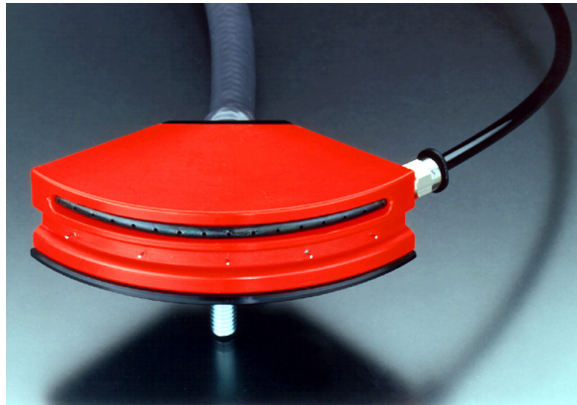

Operating instructions Delta fanning blower DA TR



V01

Air Line



Types: Delta fanning blower DA TR

Keep in a safe place for future reference!

Contents

1. Notes on operating instructions
2. Safety
3. Installation
4. Application
5. Remedy of defects
6. Maintenance and repairs
7. Technical data

1 Notes on operating instructions

In these operating instructions, the Delta fanning blower DA TR is also referred to as "unit" or "ionizing unit".

1.1 Pictorial markings used

In these operating instructions



Caution!
Important instructions!



Danger!
High voltage!
Danger of fatal accidents!



**Switch off the power pack before connecting
or disconnecting the coaxial connectors!**

In the operating instructions and on the unit



Danger!
High voltage!
Danger of fatal accidents!

2 Safety

The unit is operationally safe, provided that it is operated in accordance with its intended use. In case of misuse, dangers may result:

- For life and limb of the operator,
- For the unit and other assets.

Also note Chapter 3.1 (Important installation notes).



Special safety instructions apply to operators with heart pacemakers; please apply to HAUG for details!

2.1 Intended use

The unit generates positive and negative ions.

The units assist the air stream and are intended to eliminate electrostatic charges and contamination (e.g. dust) from paper, films and foils, textiles, glass, plastics etc.

HAUG power packs only must be used for supplying the high voltage to the units.



Do not install or use the units in areas subject to explosion hazards.

For reasons of safety, unauthorized conversions and modifications of the unit are not permitted. The installation and operating conditions indicated in these Operating Instructions must be adhered to.

2.2 Danger sources

Defective high-voltage plugs and cables may lead to danger of electric shocks. Shut down the unit immediately in case of visible damage and suspected electrical defects.



Never use air-assisted ionizers without pressure reducers and compressed air filters (refer to "Accessories")!

Never exceed the permitted maximum pressure (see "Technical data")!

Secure air hoses with suitable clamps!



Danger!
High voltage!
Danger of fatal accidents!
Do not open unit!

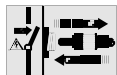

Only plug in/unplug coaxial connector when the unit is switched off!

2.3 Operator qualifications

The unit may be installed and put into operation by trained electricians only or by authorized and persons informed about the potential dangers. The above mentioned persons must have read the operating instructions and must follow the instructions, notes and safety advice. The above-mentioned persons must have been instructed in the installation and handling of compressed air units and resulting dangers.

3 Installation

The unit may be installed by trained electricians only and by authorized persons informed about the potential dangers. The above mentioned persons must have read the operating instructions and must follow the instructions, notes and safety advice. The above-mentioned persons must have been instructed in the installation and handling of compressed air units and resulting dangers.

1. Install unit (refer to Section 3.2).
2. Connect to air supply system.
3. Connect unit to power pack.

3.1 Important installation instructions

The operation of the unit is not affected by the position in which it is installed.



Never use air-assisted ionizers without pressure reducers and compressed air filters (refer to "Accessories")!
Never exceed the permitted maximum pressure (see "Technical data")!
Secure air hoses with suitable clamps!



Do not connect the units to the power pack until installation is completed.



Switch off the power pack before connecting or disconnecting the coaxial connectors!

3.2 Ionizing units

The numerals refer to the illustration at the end of these instructions.

- 1 Delta fanning blower DA TR
- 2 Most favourable distance ionizing unit - material approx. 20 - 300 mm, min. 10 mm, max. 500 mm.
- 3 Distance B to grounded machine part always greater than distance A.
- 4 Install high-voltage cables without kinks. Smallest bending radius 50 mm.

4 Application

The unit may be put into operation by trained electricians only or by persons instructed in the potential dangers. The above mentioned persons must have read the operating instructions and must follow the instructions, notes and safety advice. The above-mentioned persons must have been instructed in the handling of compressed air units and resulting dangers.

Conditions:

The power pack and the ionizing unit must be connected correctly.

The ionizing units are used in connection with compressed air and HAUG power packs to eliminate electrostatic charges and contamination (e.g. dust) from paper, films and foils, textiles, glass, plastics etc.

The unit is intended for fanning individual sheets of paper and film stacks.

The unit can be used for cleaning contaminants adhering to surfaces electro statically.

Figure 1: Fanning of individual sheets of paper stacks

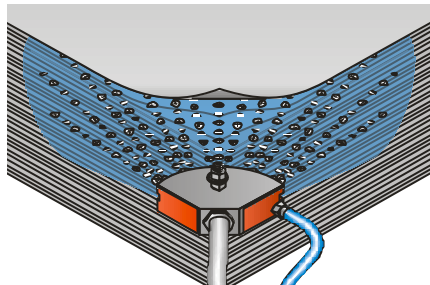

Figure 1

4.1 Putting into operation

1. Switch on compressed air supply.
2. Switch on power pack.

5 Remedy of defects

Any remedy of defects must be carried out by trained electricians only. The above mentioned persons must have read the operating instructions and must follow the instructions, notes and safety advice. The above-mentioned person must have been instructed in the installation and handling of compressed air units and resulting dangers.

In case of defects regarding the power pack and the ionizing unit, please check for correct installation first. If this does not solve the problem, please return the power pack together with the ionizing unit for examination.



Danger!
High voltage!
Danger of fatal accidents!



***Switch off the power pack before connecting
or disconnecting the coaxial connectors!***

6 Maintenance and repairs



Danger!
High voltage!
Danger of fatal accidents!

This unit does not include any parts which can be repaired by the operator.

Should the unit prove defective or if a defect is suspected, switch off unit immediately and secure against subsequent reuse.

6.1 Cleaning



Clean at intervals of no more than 14 days using the special cleaning brush or the special cleaning system (refer to "Accessories").

6.2 Accessories

Compressed air service station 3/4"	11.7210.001
Compressed-air hose	X – 6619
Special cleaning fluid	10.7220.000
Special cleaning brush	10.7218.000
Special cleaning system	10.7218.001
Circular brush for special cleaning system	X – 6822

7 Technical data

7.1 Supply voltage

The ionizing units are provided with high voltage from HAUG power packs.

7.2 Compressed air

Maximum pressure

5 bar, free of oil and aerosols

Air consumption

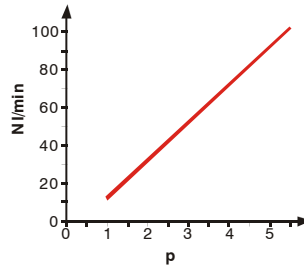

Range of effectiveness

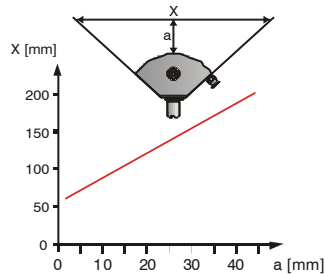

7.3 Ambient conditions

Ambient temperature:

Rated application range

+5 °C to +45 °C

Extreme range for storage and transport

-15 °C to +60 °C

Humidity:

Rated application range

20 % to 65 % RH

Extreme range for storage and transport

0 % to 85 % RH

7.4 Dimensions

Height:	approx. 52 mm
Width:	approx. 85 mm
Depth:	approx. 21 mm
High tensions lead	Length customer-specific
Compressed-air hose	Length customer-specific

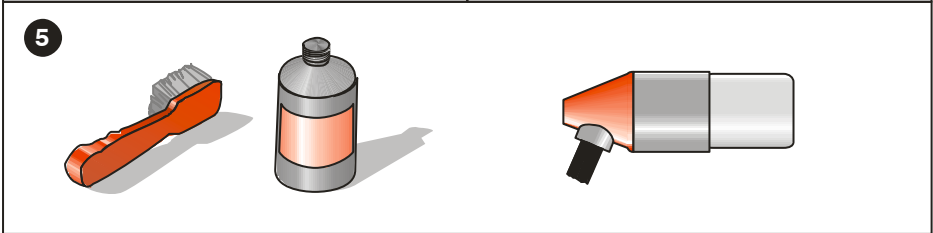
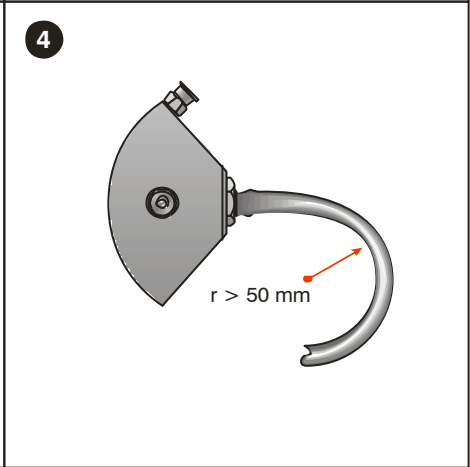
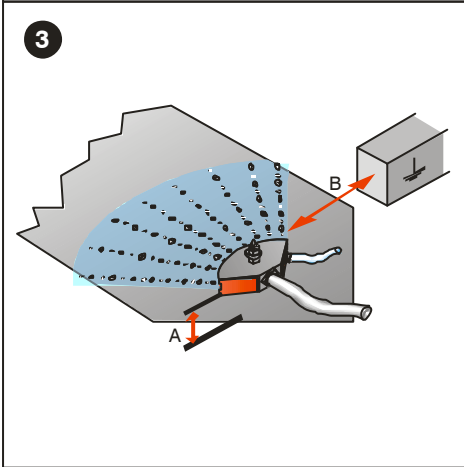
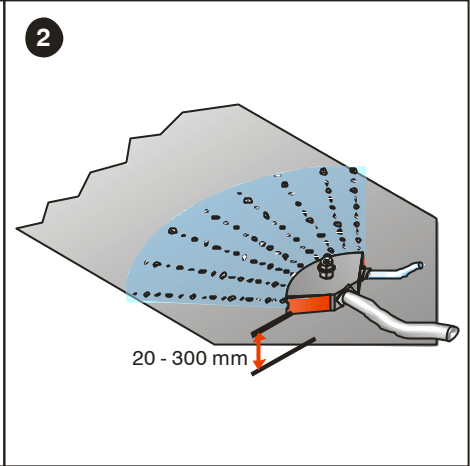
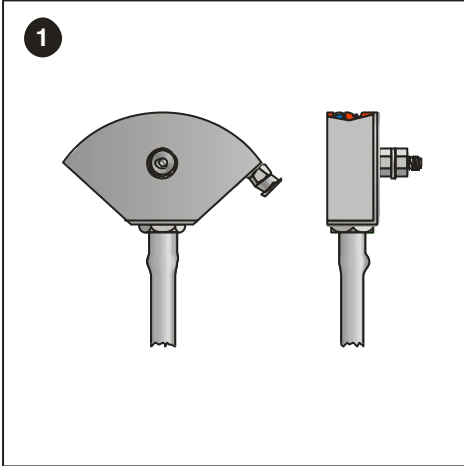



made by



HAUG GmbH & Co.KG

Friedrich-List-Straße 18
D-70771 Leinfelden-Echterdingen
Telefon 07 11 / 94 98 - 0
Telefax 07 11 / 94 98 - 298

www.haug.de
E-Mail: info@haug.de

HAUG Biel AG

Postfach
CH-2500 Biel/ Bienne 6
Johann-Renfer-Strasse 60
CH-2500 Biel/ Bienne 6
Telefon 0 32 / 3 44 96 96
Telefax 0 32 / 3 44 96 97

www.haug.de
E-Mail: info@haug-biel.ch